

Article number: 12348000080110
Description: KLEE-coil 348 000 080.110
M 8 Hardened/zinc-plated Blue

Measures

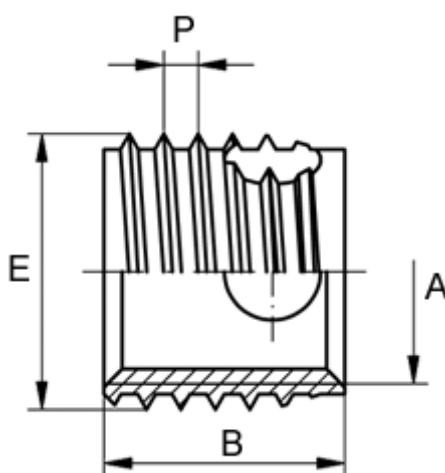

Female thread A	= M8
Length B	= 14
Male thread E	= 10.0
Min hole depth blind hole	= 17
Pre-drilled max	= 9.6
Pre-drilled min	= 9.4
Thread pitch P	= 1.25
Type	= 348 000 080 ...